

45 SL 10
Kasa Profili
Frame Profile
 $J_x=94,19 \text{ cm}^4$
 $J_y=132,76 \text{ cm}^4$
Ağırlık :2,38 kg/m
(Weight)

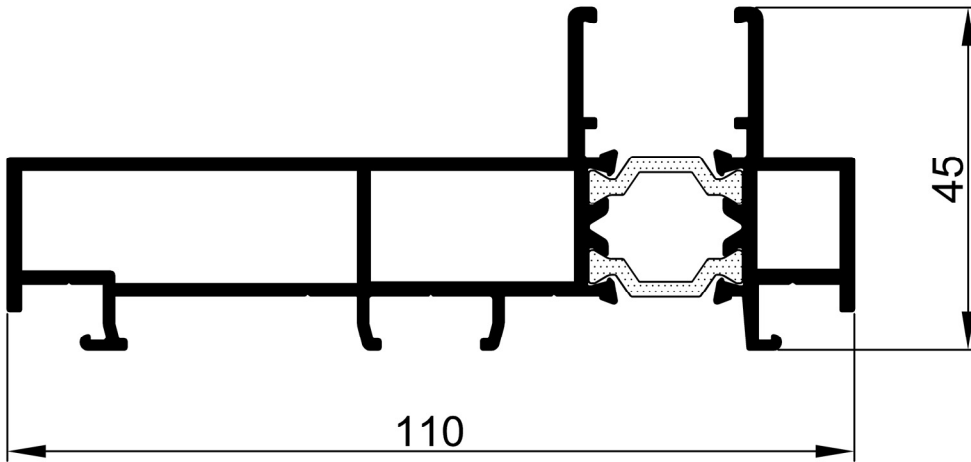

45 SL 11
Kasa Profili
Frame Profile
 $J_x=6,51 \text{ cm}^4$
 $J_y=71,36 \text{ cm}^4$
Ağırlık :1,83 kg/m
(Weight)

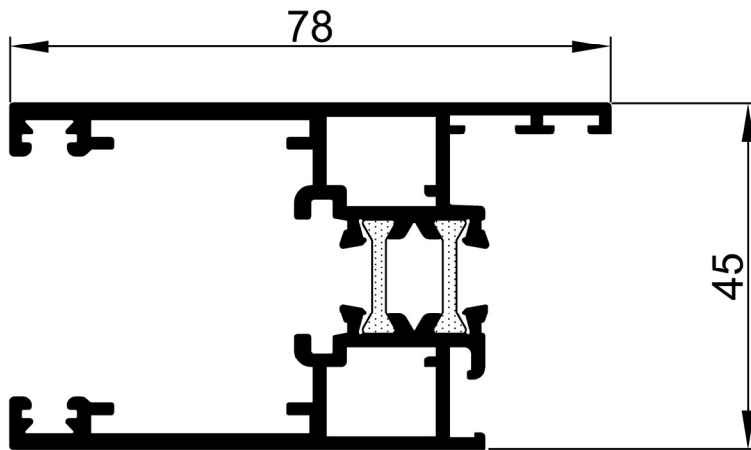

45 SL 20
Kanat Profili
Sash Profile
 $J_x=22,19 \text{ cm}^4$
 $J_y=16,92 \text{ cm}^4$
Ağırlık :1,59 kg/m
(Weight)

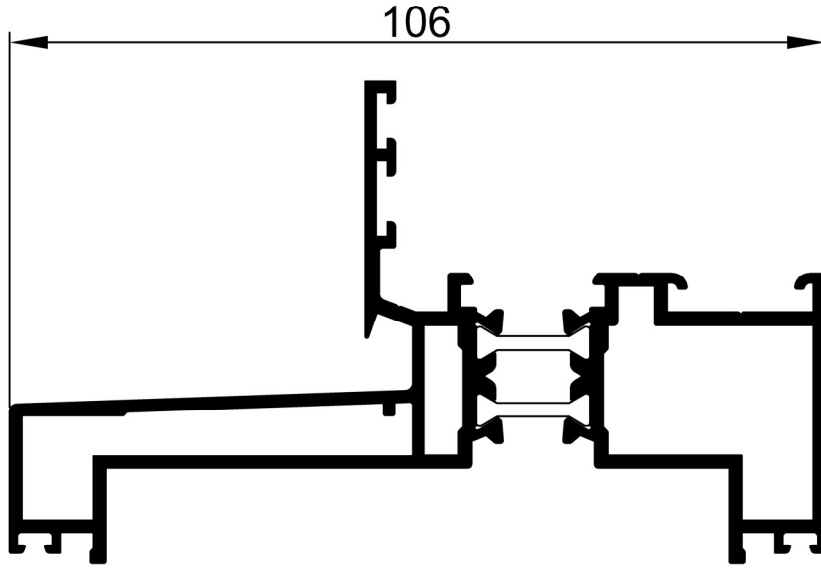

45 SL 40
Sabite Geçiş Profili
Connection Adapter
for Fixed Parts Profile
 $J_x=10,83\text{cm}^4$
 $J_y=64,75\text{cm}^4$
Ağırlık :1,888 kg/m
(Weight)

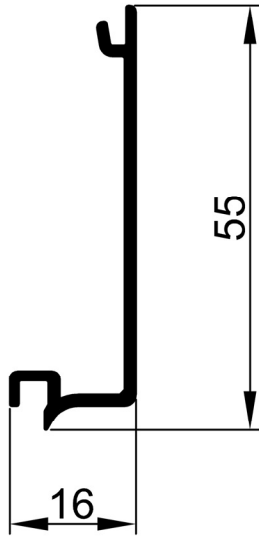

45 SL 50
Kenet Profili/Sash Profile
Ağırlık :0,32 kg/m
(Weight)

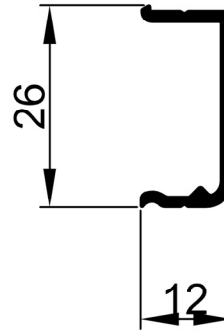

45 SL 52
Kapak Profili
Cover Profile
Ağırlık :0,19 kg/m
(Weight)

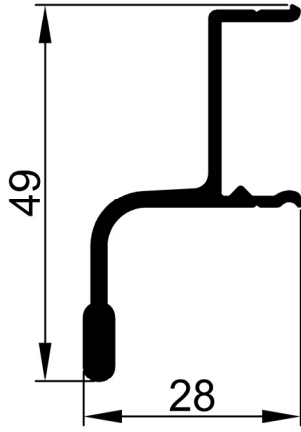

45 SL 51
Damlalık Profili
Weatherdrip Profile
Ağırlık :0,44 kg/m
(Weight)

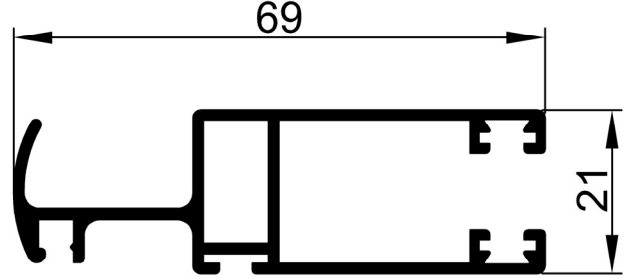

10 - 3126
Sineklik Profili
Flyscreen Profile
Ağırlık :1,12 kg/m
(Weight)

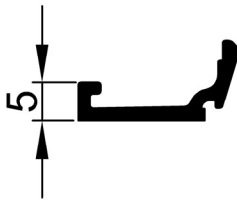

10 - 3133
Cam Çıtası/*Glazig Bead*
Ağırlık :0,15 kg/m
(Weight)

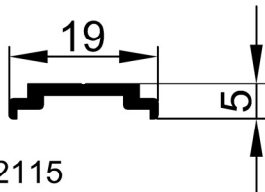

04-2115
Tij Profili/*Push Rod Profile*
Ağırlık : 0,098 kg/m
(Weight)

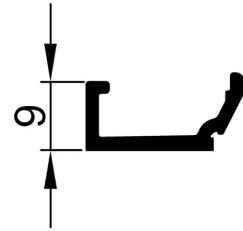

10 - 3244
Cam Çıtası/*Glazig Bead*
Ağırlık :0,16 kg/m
(Weight)

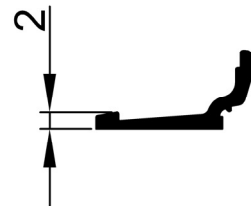

11 - 3202
Cam Çıtası/*Glazig Bead*
Ağırlık :0,12 kg/m
(Weight)

Camlama Seçenekleri

Glazing Options

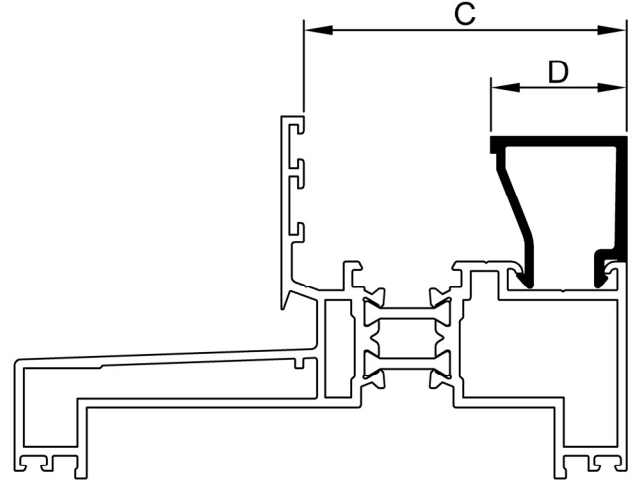
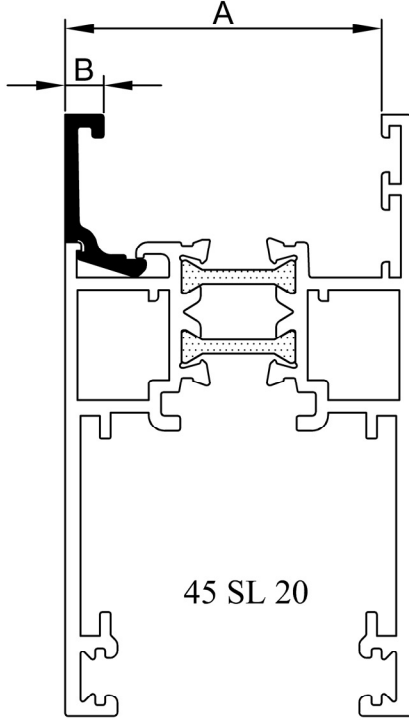

KANAT PROFİLİ / SASH PROFILE				
A = 41 mm				
Montaj Yüksekliği / Construction Depth				
Cam (Glass)	Cam Çıtası (Glazing Bead)	B(mm)	İç Cam Fiteli (Internal Glazing Gasket)	Dış Cam Fiteli (External Glazing Bead)
24	10-3244	9	MN 201 (5mm)	40 D 02 (3mm)
28	10-3133	5	MN 201 (5mm)	40 D 02 (3mm)

KANAT PROFİLİ / VENT PROFILE				
C = 56 mm				
Montaj Yüksekliği / Construction Depth				
Cam (Glass)	Cam Çıtası (Glazing Bead)	D (mm)	İç Cam Fiteli (Internal Glazing Gasket)	Dış Cam Fiteli (External Glazing Bead)
15	3114	33	MN 201 (5mm)	40 D 02 (3mm)
17	3114	33	40 D 03 (3mm)	40 D 02 (3mm)
18	3113	30	MN 201 (5mm)	40 D 02 (3mm)
20	3113	30	40 D 03 (3mm)	40 D 02 (3mm)
21	3112	27	MN 201 (5mm)	40 D 02 (3mm)
23	3112	27	40 D 03 (3mm)	40 D 02 (3mm)
24	3111	24	MN 201 (5mm)	40 D 02 (3mm)
26	3111	24	40 D 03 (3mm)	40 D 02 (3mm)
27	3110	21	MN 201 (5mm)	40 D 02 (3mm)
29	3110	21	40 D 03 (3mm)	40 D 02 (3mm)
30	3109	18	MN 201 (5mm)	40 D 02 (3mm)
32	3109	18	40 D 03 (3mm)	40 D 02 (3mm)
33	3108	15	MN 201 (5mm)	40 D 02 (3mm)
35	3108	15	40 D 03 (3mm)	40 D 02 (3mm)
36	2606	12	MN 201 (5mm)	40 D 02 (3mm)
38	2606	12	40 D 03 (3mm)	40 D 02 (3mm)
39	3145	9	MN 201 (5mm)	40 D 02 (3mm)
41	3145	9	40 D 03 (3mm)	40 D 02 (3mm)
42	3144	6	MN 201 (5mm)	40 D 02 (3mm)
44	3144	6	40 D 03 (3mm)	40 D 02 (3mm)

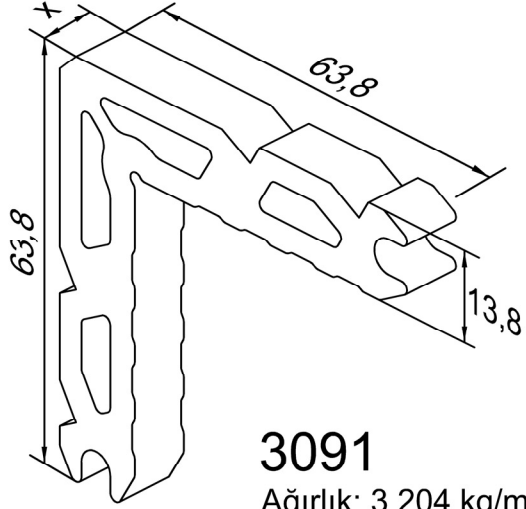

Köşe Takoz No Corner Cleat No	Sembol Symbol	Kullanıldığı Profiller Used Profiles	x-Kesim Ölçüleri (mm) x-Cutting Dimensions
3091		45 SL 20	2 adet - 9 mm
3093		45 SL 10	8,5
			32
			35
3089		45 SL 40	26
3081		45 SL 40	4
			50

